

Required tools

Herramientas necesarias

Outils nécessaires

Phillips screwdriver
Destornillador phillips
Tournevis cruciforme

Pencil
Lápiz
Crayon

Power drill
Taladro eléctrico
Perceuse électrique

Drill bit
Broca
Foret

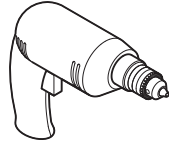
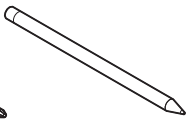
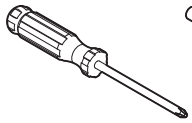

Parts in the box

Piezas en la caja

Pièces dans la boîte

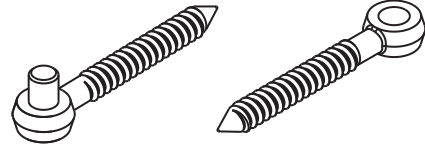

1

Mark the locations of the hinges and gate.
Marque la ubicación de las bisagras y la puerta.
Marquez l'emplacement des charnières et de la porte.

Gate
Puerta
Portail

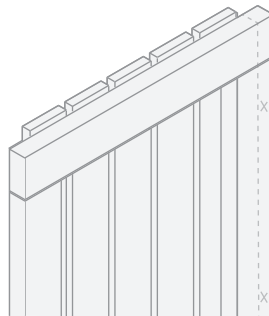

Post
Poste
Poteau

2

Drill the pilot holes on the post and gate.
Taladre los agujeros piloto en el poste y la puerta.
Percez les avant-trous sur le poteau et le portail.

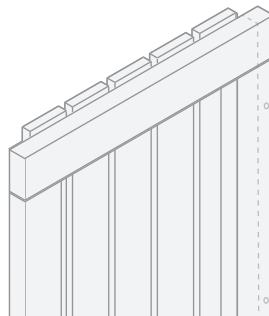

5/16"
8 mm

3

Secure the hinges.
Asegure las bisagras.
Fixez les charnières.

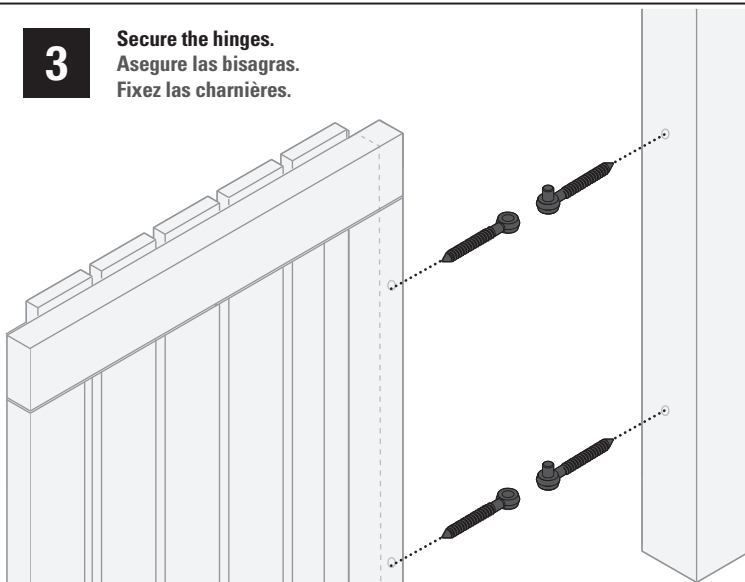

4

Place the gate on the post.
Coloque la puerta en el poste.
Placez le portail sur le poteau.

