

**Required tools**  
**Herramientas necesarias**  
**Outils nécessaires**

Phillips screwdriver  
Destornillador phillips  
Tournevis cruciforme

Pencil  
Lápiz  
Crayon

Power drill  
Taladro eléctrico  
Perceuse électrique

Drill bit  
Broca  
Foret

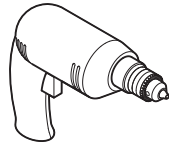
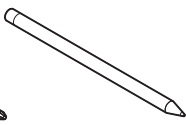
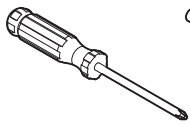

**Parts in the box**  
**Piezas en la caja**  
**Pièces dans la boîte**

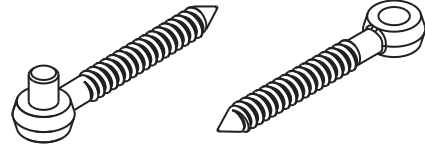

**1**

**Mark the locations of the hinges and gate.**  
**Marque la ubicación de las bisagras y la puerta.**  
**Marquez l'emplacement des charnières et de la porte.**

**Gate**  
**Puerta**  
**Portail**

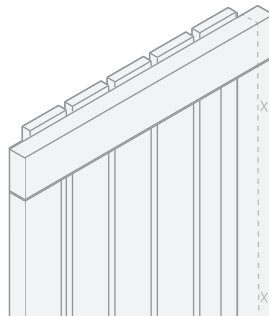

**Post**  
**Poste**  
**Poteau**

**2**

**Drill the pilot holes on the post and gate.**  
**Taladre los agujeros piloto en el poste y la puerta.**  
**Percez les avant-trous sur le poteau et le portail.**

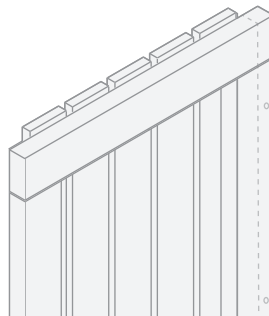

**5/16"**  
**8 mm**

**3**

**Secure the hinges.**  
**Asegure las bisagras.**  
**Fixez les charnières.**

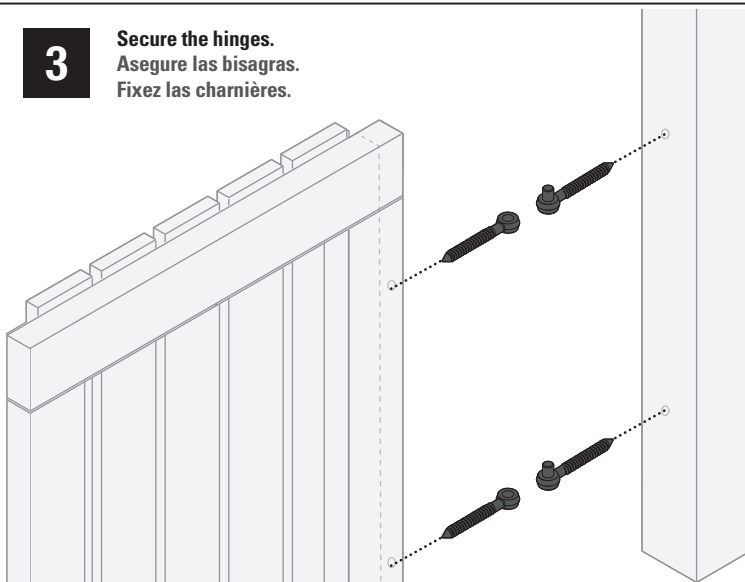

**4**

**Place the gate on the post.**  
**Coloque la puerta en el poste.**  
**Placez le portail sur le poteau.**

