

∅ .23 THRU  
 C' SNK FOR #7  
 FL HD SCREW  
 ( 6 PLCS )

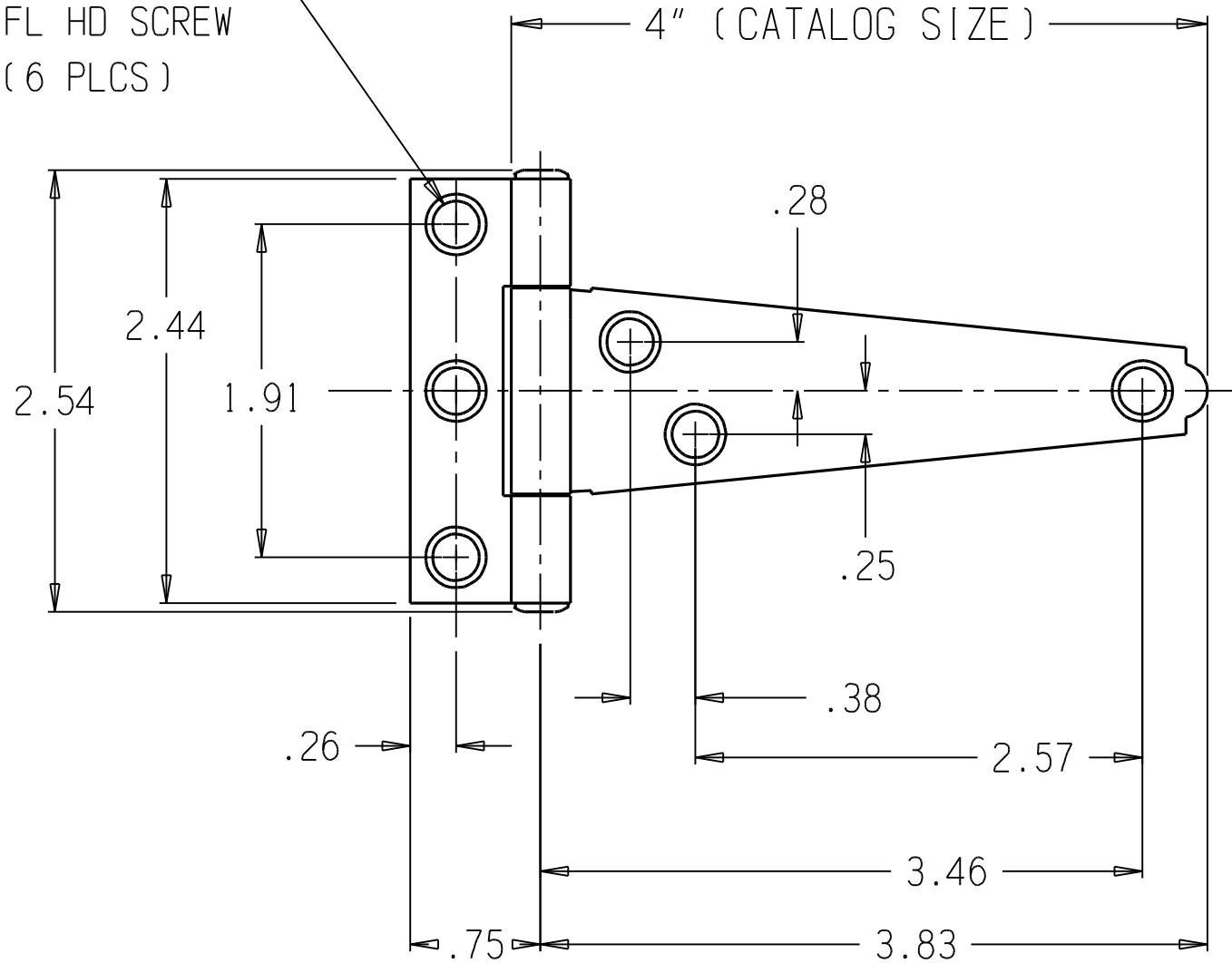

Dimensions shown are nominal and  
 subject to change. For critical design  
 specification, contact [techinfo@natman.com](mailto:techinfo@natman.com)  
 2007 National Manufacturing Co.

MATERIAL: 0.056" NOMINAL  
 PIN DIA: 0.195"

NATIONAL 284 4" T-HINGE