

.06 DIA

.14 DIA

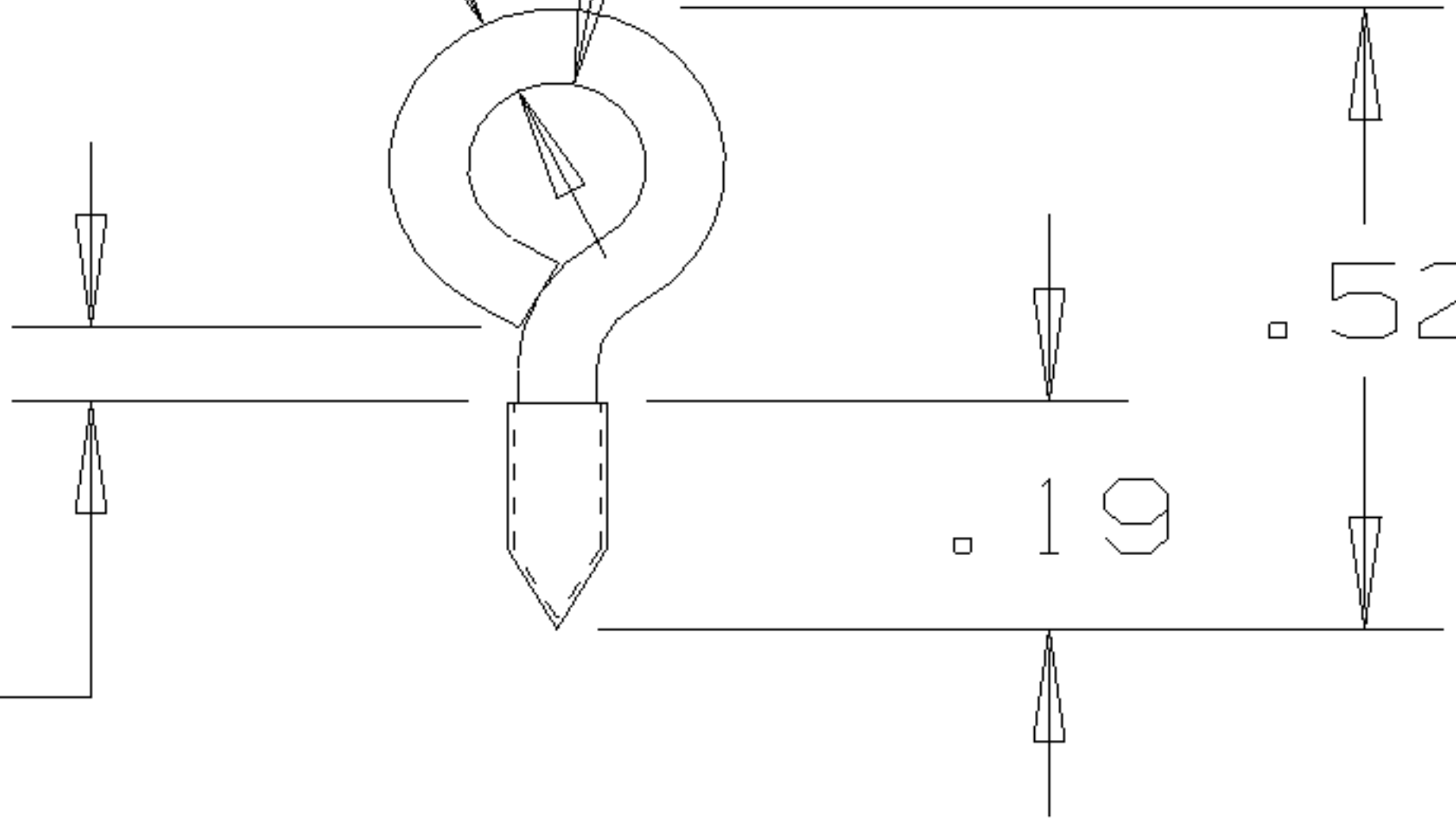

.06

.19

.52

Dimensions shown are nominal and subject to change. For critical design specification, contact [techinfo@natman.com](mailto:techinfo@natman.com)  
©2000 National Manufacturing Co.