

Required tools

Herramientas necesarias

Outils nécessaires

Phillips
screwdriver
Destornillador
phillips
Tournevis
cruciforme

Pencil
Lápiz
Crayon

Hex key
Llave hexagonal
Clé hexagonale

Power drill
Taladro eléctrico
Perceuse électrique

Drill bits
Brocas
Forets

Stud finder
Detector
de vigas
Recherche
de goujons

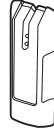
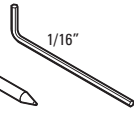
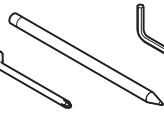
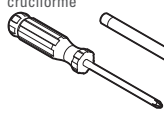

Parts in the box

Piezas en la caja

Pièces dans la boîte

Wall screw
Tornillo de pared
Vis murale

Base
Base
Base

Trim
Moldura
Garniture

Adaptor
Adaptador
Adaptateur

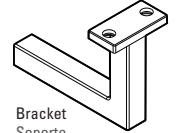
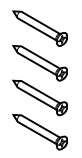

Rail screws
Tornillos de carril
Vis de rail

Set screw
Tornillo de fijación
Vis de réglage

Bracket
Soporte
Support

1

Locate studs, mark holes on wall and rail, and drill holes.
Ubique los montantes, marque los agujeros en la pared y el riel, y perfora los agujeros.
Localisez les montants, marquez les trous sur le mur et le rail et percez des trous.

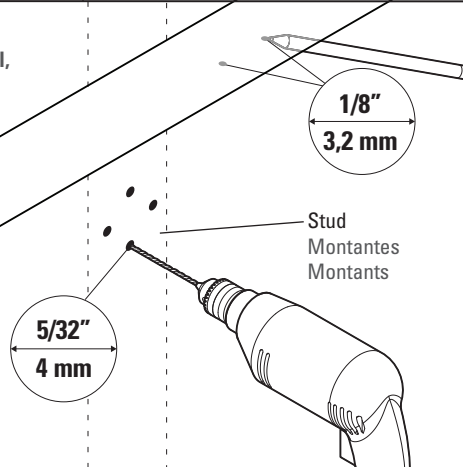

2

Secure base with wall screws, then install trim and bracket.
Asegure la base con tornillos de pared, luego instale la moldura y el soporte.
Fixez la base avec des vis murales, puis installez la garniture et le support.

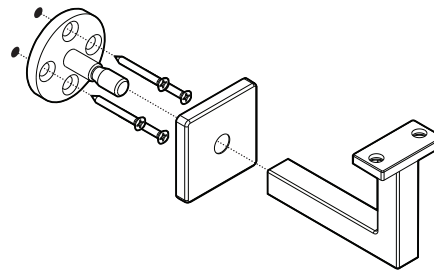

3

Secure rail to bracket with rail screws. Then adjust alignment of bracket and tighten set screw securely.
Asegure el riel al soporte con tornillos para riel. Luego ajuste la alineación del soporte y apriete firmemente el tornillo de fijación.
Fixez le rail au support avec des vis de rail. Ensuite, ajustez l'alignement du support et serrez fermement la vis de réglage.

